MODEL NUMBER 4-3062*

ITEM NO.	PART DESCRIPTION	PART NUMBER	QUAN.
1	TRIPOD HEAD	2573-0000	1
2	PIN ASSEMBLY	1999-0000	3
3	EYE BOLT 3/4-10NC X 6 LG.	73-0080	1
4	HEX. NUT 3/4-10NC	54-0040	2
5	FLAT WASHER	56-0010	1
6	SWIVEL WASHER	2187-0000	1
7	TRIPOD LEG ASSEMBLY	2978	3
8	TRIPOD FOOT	3044-0001	3
9	PIN TRIPOD FOOT	2853-0000	3
10	KEY RING 2 1/4 DIA.	82-0030	3
11	LASHING CABLE ASSEMBLY 17'0" LG.	3348-0018	1
12	WIRE ROPE CLIP	71-0100	2

*****OPTIONAL ACCESSORIES*****

13	TRIPOD RUBBER BASE PAD	3045-0001	3
14	PIN TRIPOD RUBBER BASE PAD	1459-0000	3
15	KLIK PIN - 1/4 DIA.	81-0010	3
16	COTTER PIN 1/4 X 1-1/4 LG.	60-0070	3
17	TRIPOD SPIKE BASE	2934	3
18	MUD BASE PLATE	1097-0000	3

* = FIXED HEIGHT MODELS

When Ordering Tripod Parts, Specify Model Number, Capacity,
Part Number and Description

Parts Location
Drawing for

Fixed Height Tripods
4 - Series Models

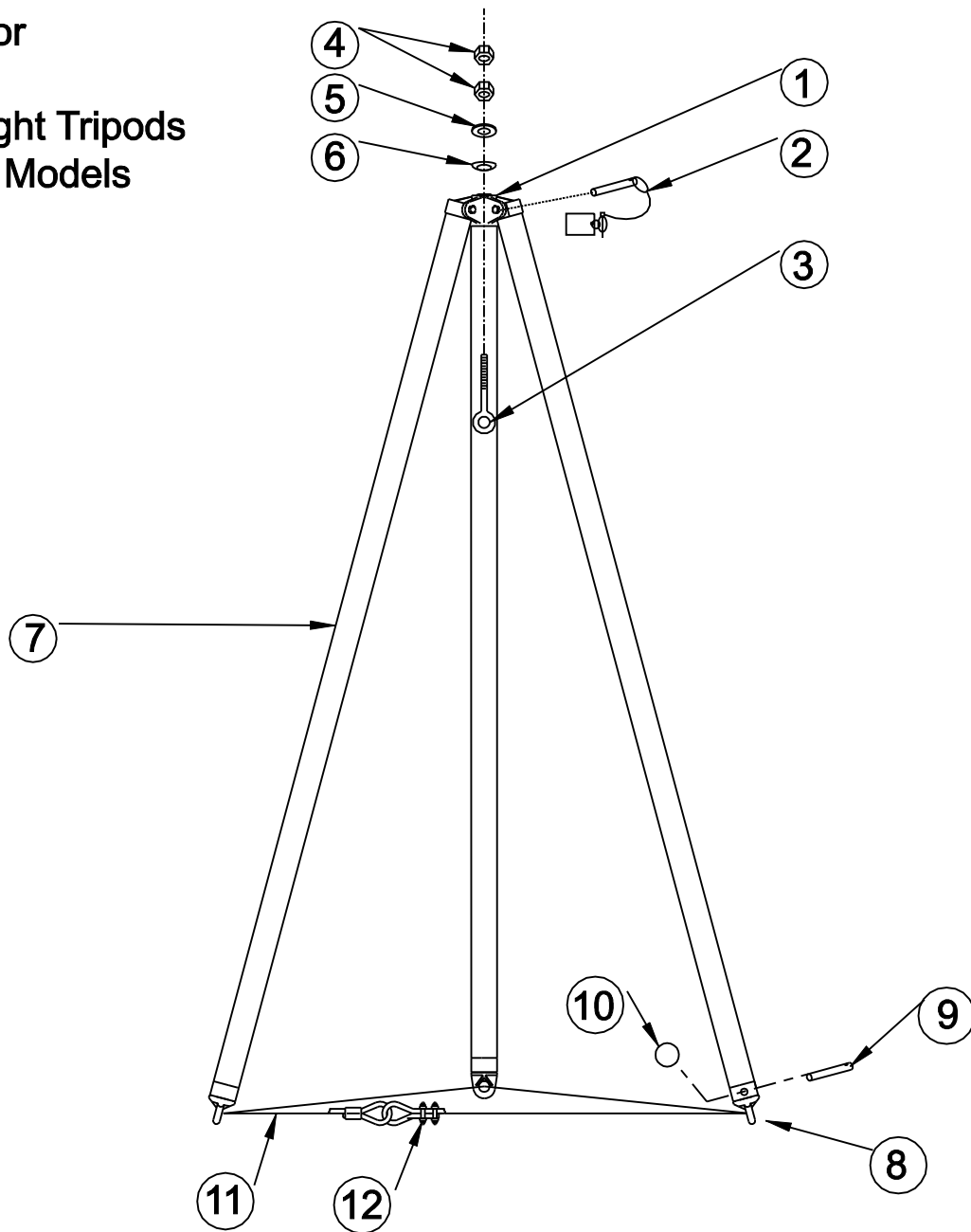

Optional Accessories

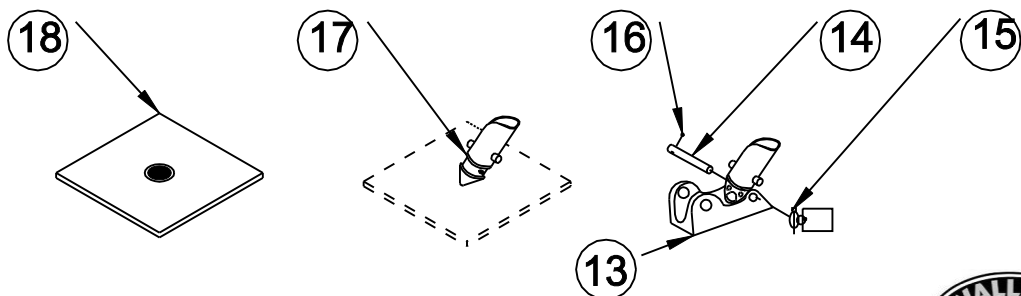

NOTE: The Lashing Kit provided with the Tripod must be used.

The Lashing Cable is installed through the holes in the Tripod foot or rubber base pad. The free end is then put through the loop end of the cable and terminated as shown using the two Fist Grip Clips to complete the assembly. Torque bolts to 30 ft/lbs.

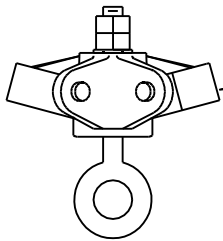

Detail of head.
Nut is shown on top,
Hemispherical washer is
below the nut, curved side down.

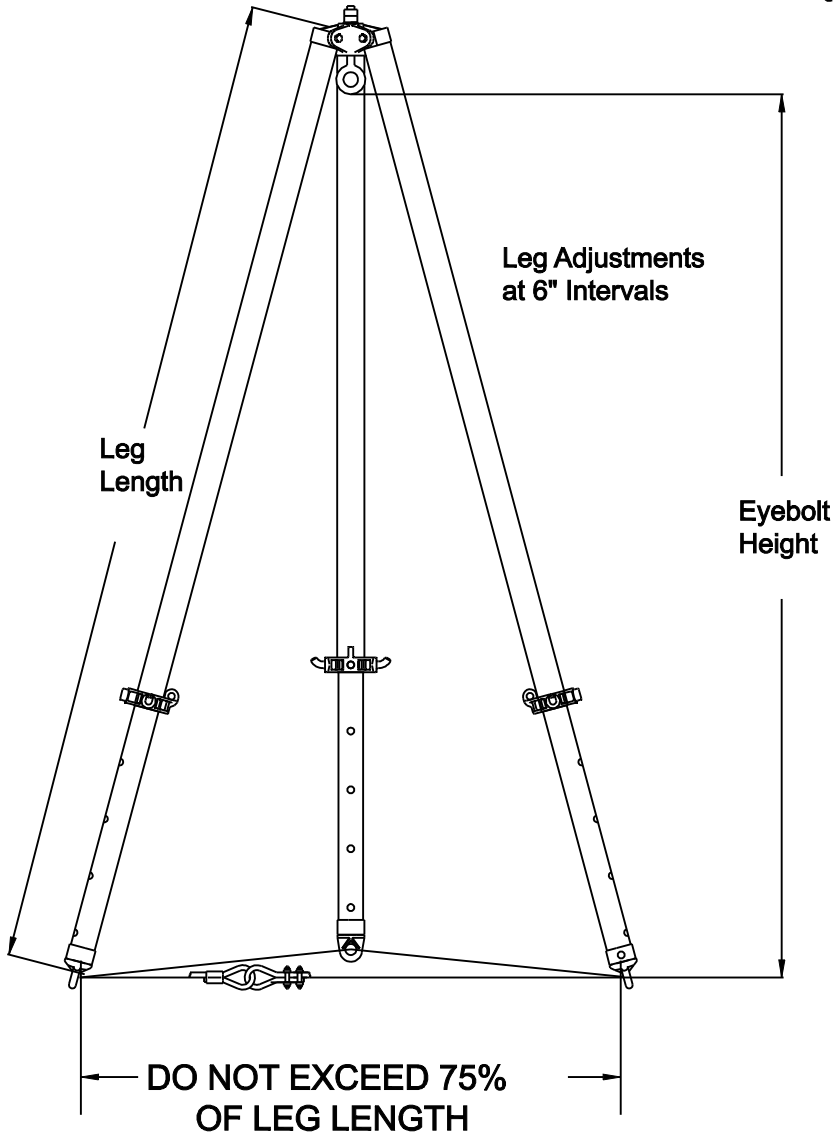

LASHING CABLE ASSEMBLY

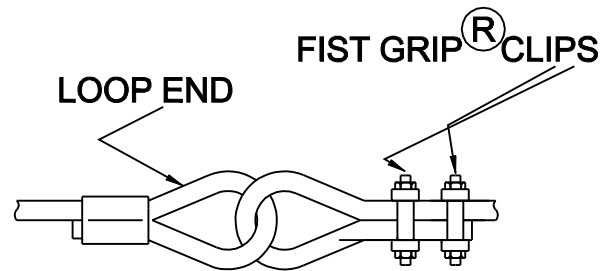

OPTIONAL ACCESSORIES

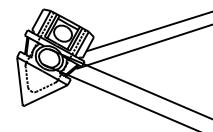

**SPIKE BASE
KIT NO 676**

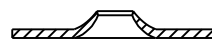

**MUD BASE PLATE
KIT NO. 1097**

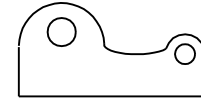

**RUBBER BASE PAD
KIT NO 675**

UNLESS OTHERWISE SPECIFIED DIMENSIONS ARE IN INCHES TOLERANCES ON				Wallace Products Corp. FRAZER, PENNSYLVANIA			
FRACTION ±1/64"		DECIMAL ±0.000"		TITLE TRIPOD INSTRUCTIONS			
DRAWN BY	DATE	SCALE	WT.	DWG C SIZE	DRAWING NO.	REV.	
CHECKER		NTS					
APPROVAL							
NEXT ASSY	SYMBOL	DESCRIPTION	DATE	INT.	REVISIONS		