

MODEL NUMBER 8T10-S10

ITEM NO.	PART DESCRIPTION	PART NUMBER	QUAN.
1	SUPPORT PIN 1 DIA. X 8 1/4 LG.	5413-0000	4
2	MAIN LEG BRACKET	6115-1	4
3	HEX. NUT 3/8-24NF	54-0100	8
4	SOC. SET SCREW 3/8-24NF X 1 3/4 LG.	63-0110	8
5	SUPPORT PIN 3/4 DIA. X 6 1/4 LG.	5129-0001	4
6	SPACER BAR 12 1/4 LG.	5307-1225	2
7	BRACE LEG BRACKET	6115-2	4
8	I-BEAM STL. 15" X 10' LG.	768-0100	1
9	KEY RING 2 1/4 DIA.	82-0030	16
10	CAUTION TAG No. 399	1969-RING	12
11	LOCK WASHER INT. TOOTH 3/4	58-0040	4
12	HEX. NUT 3/4-10NC	54-0040	4
13	TROLLEY STOP ANGLE	5132-0000	4
14	HEX. HD. BOLT 3/4-10NC X 2 1/2 LG.	51-0480	4
15	BRACE LEG	5135-0004	4
16	MAIN LEG ASSEMBLY	5106-0061	4
17	UPPER MAIN LEG	5155-0004	4
18	ROLL PIN 5/32 X 3/4 LG.	61-0300	4
19	LOAD PIN CASTING	5111-0000	4
20	EXTENSION SPRING	5117-0000	8
21	LOWER MAIN LEG	5157-0004	4
22	SAFETY STOP ASSEMBLY	5140-0000	4
23	CASTER FRAME ASSEMBLY	5107-0061	2
24	SAFETY CABLE ASS'Y 61" LG.	5028-0004	2
25	OUTER CASTER FRAME TUBE	5136-0004	2
26	CASTER FRAME ADJUSTMENT PIN	5139-0000	2
27	INNER CASTER FRAME TUBE	5137-0004	2
28	HEX. HD. BOLT 1/2-13NC X 3 1/2 LG.	51-0460	2
29	CASTER PLATE	5161-0000	4
30	LOWER MAIN LEG PIN 1 DIA. X 6 7/16 LG.	5018-0000	4
31	HEX. HD. BOLT 1/2-13NC X 5 LG.	51-0110	6
32	HEX. HD. BOLT 1/2-13NC X 1 3/4 LG.	51-0300	32
33	CASTER WHEEL 10" DIA.	47-0250	8
34	LOCK WASHER INT. TOOTH 1/2	58-0020	40
35	HEX. NUT 1/2-13NC	54-0050	40
36	COTTER PIN 1/4 X 2 LG.	60-0040	4



Wallace Cranes Parts Location

Square Tube Tri-Adjustable 8 & 10 Ton

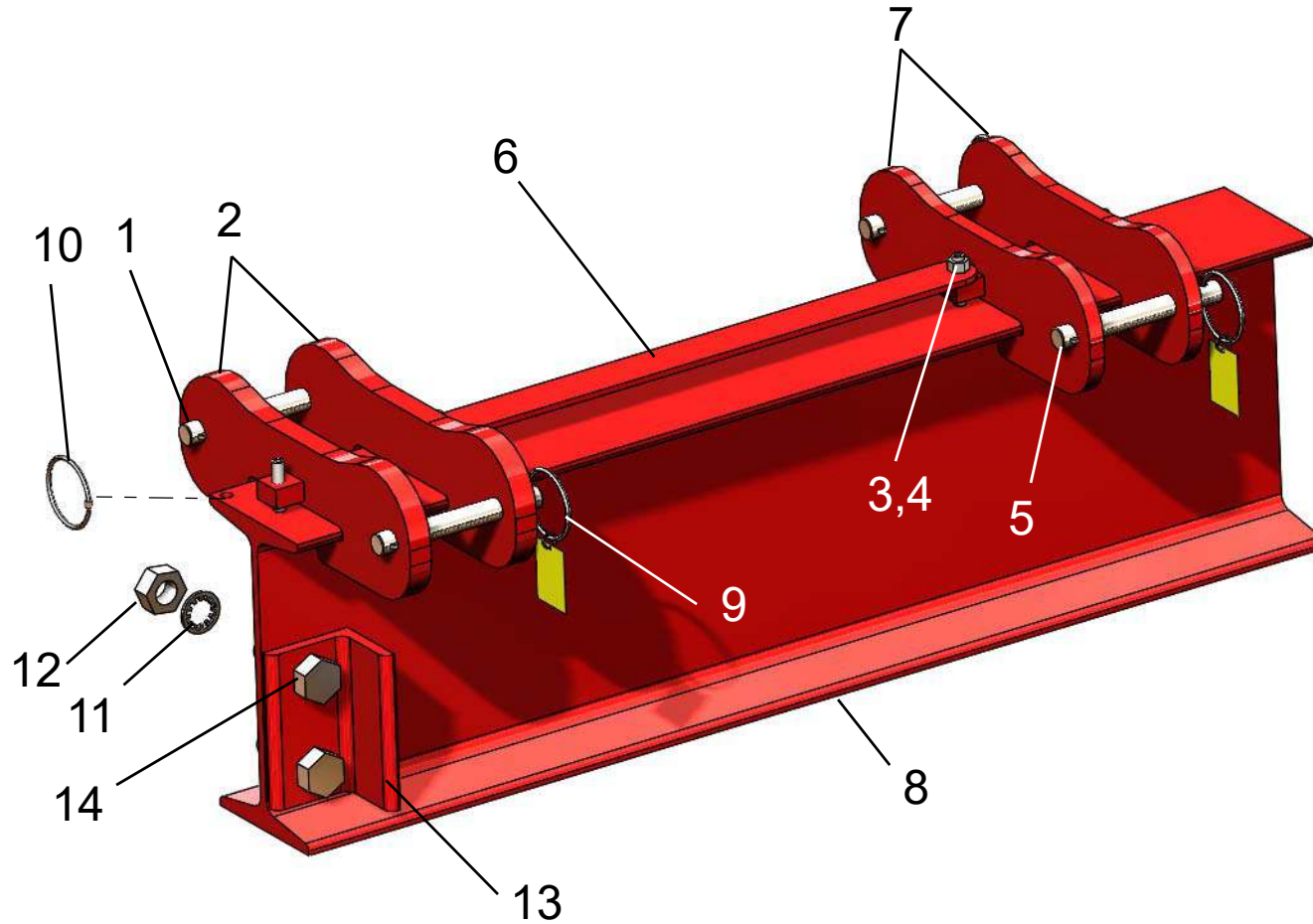

I-Beam
Assembly
Parts Location

Wallace Cranes
71 N Bacton Hill Rd.
Malvern, PA 19355



www.wallacecranes.com
800-553-5438
©2017 All rights reserved

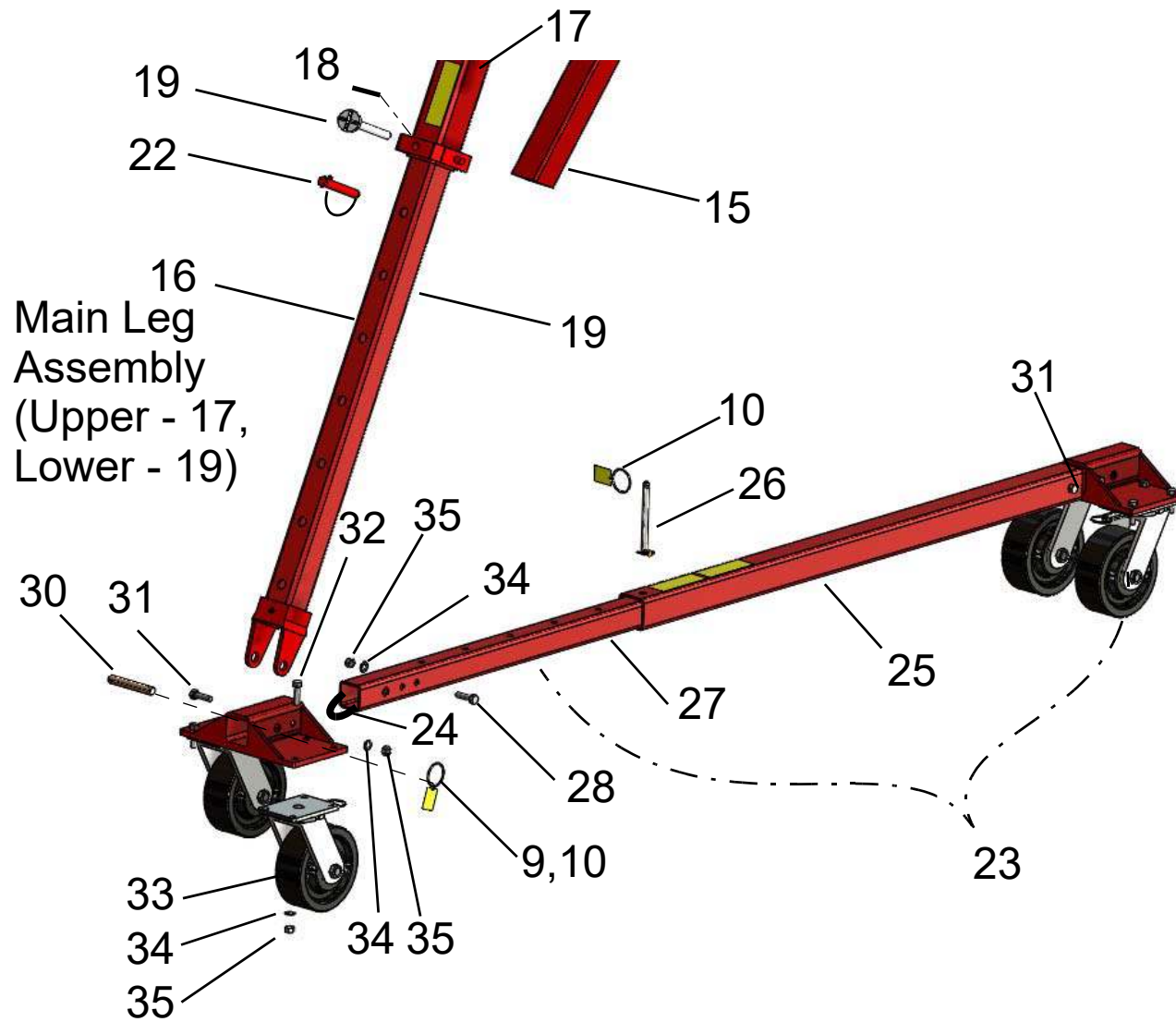

Caster Frame
Assembly
Parts Location



Alternate
V-Groove Caster
Part No. 5141

Wallace Cranes
71 N Bacton Hill Rd.
Malvern, PA 19355



www.wallacecranes.com
800-553-5438
©2017 All rights reserved



WALLACE CRANES PORTABLE CRANE CANTILEVER CHART

GANTRY MODEL NUMBER: 8T10-S10
 I-BEAM: S15" X 42.9#/' X 10'
 I-BEAM LENGTH (OVERALL SPAN): 120 Inches
 MAXIMUM CANTILEVER DISTANCE (A): 30 Inches
 GANTRY RATED CAPACITY: 16,000 Lbs.
 MAXIMUM CANTILEVERED LOAD (B): 9600 Lbs.
 GANTRY WEIGHT: 1823 Lbs.
 I-BEAM WEIGHT: 429 Lbs.

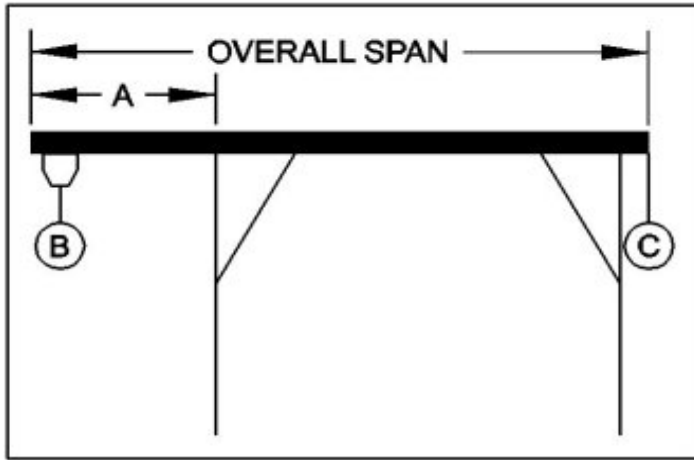

PROPER CANTILEVER PROCEDURES
 Required counterweight should not be supported by gantry caster frame.

Load and trolley should be able to freely traverse the I-beam through the main legs and brace legs of the gantry.

REQUIRED COUNTERWEIGHT AT [C]

A	B	B	B	B	B	B	B	B
IN	1200	2400	3600	4800	6000	7200	8400	9600
FEET	LBS.	LBS.	LBS.	LBS.	LBS.	LBS.	LBS.	LBS.
1	0	0	0	179	445	712	979	1245
2	0	342	942	1542	2142	2742	3342	3942
2.5	0	760	1560	2360	3160	3960	4760	5560