

1/25/2017

PARTS LIST
www.wallacecranes.com

MODEL NUMBER 5-12M-10

ITEM NO.	PART DESCRIPTION	PART NUMBER	QUAN.
1	I-BEAM	749-0100	1
2	I-BEAM BRACKET ¹	6051-0400	8
3	SPACE BAR	1744-0011	2
4	TROLLEY STOP ANGLE	6054-0000	4
5	TROLLEY STOP BOLT	51-0095	4
6	TROLLEY STOP NUT	54-0080	4
7	TROLLEY STOP LOCKWASHER	58-0080	4
8	SAFETY KEY RING & TAG ASS'Y	82-0030-1969	26
9	UPPER MAIN LEG 2"	6055-0120	4
10	LOWER MAIN LEG 1-3/4"	6056-0120	4
11	BRACE LEG 2"	6053-0120	4
12	CASTER FRAME 2"	6052-0120	2
13	MAIN LEG SUPPORT PIN 1/2" X 4" LG	6060-0001	4
14	BRACE LEG SUPPORT PIN 1/2" X 4-3/16 LG	6060-0002	4
15	LOAD PIN 1/2" DIA.	6061-0000	8
16	BRACE LEG PIN 1/2" X 3-1/2" LG	6060-0003	4
17	CASTER FRAME PIN 1/2" X 3-1/4" LG	6060-0004	4
18	SWIVEL CASTER	N/A	
19	CASTER BOLT 3/8"-16NC X 1-1/2"	N/A	
20	CASTER NUT 3/8"-16NC	N/A	
21	CASTER LOCKWASHER 3/8"	N/A	
22	I-BEAM STABILIZER	1459-MM04	2
23	I-BEAM STABILIZER NUT 3/8"-16NC	54-0060	4
24	I-BEAM STABILIZER BOLT 3/8"-16NC X 1"	51-0190	4
25	I-BEAM STABILIZER CLIP	3286-0000	4
26	I-BEAM STABILIZER LOCKWASHER 3/8"	58-0060	4

¹ = INCLUDES A SET SCREW (63-0100) & HEX NUT (54-0100)

Wallace Products Corp.
Mighty-Mite
Parts Location Diagram

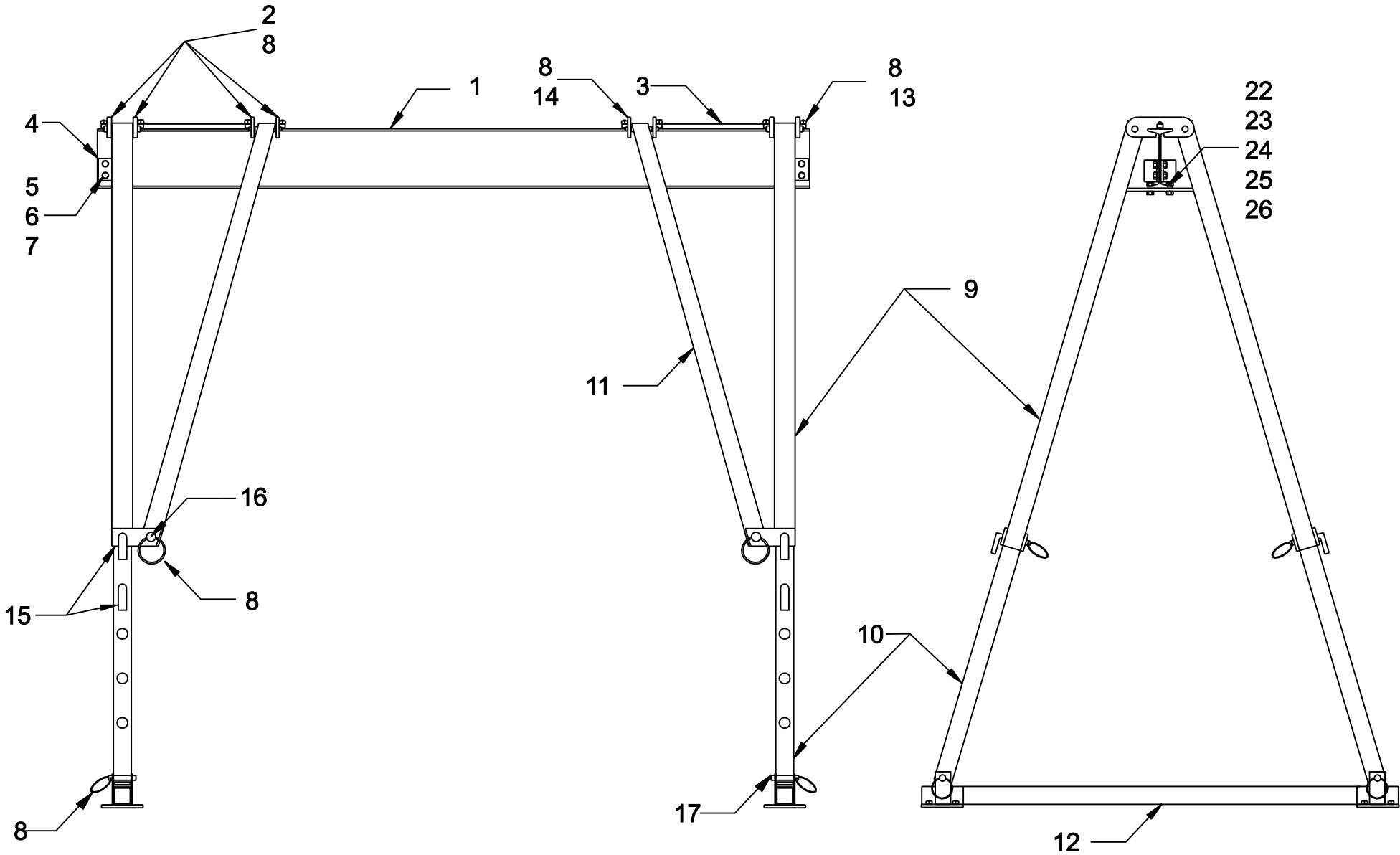

Wallace Cranes Mighty Mite I-Beam Stabilizer Parts Location Diagram





WALLACE CRANES PORTABLE CRANE CANTILEVER CHART

GANTRY MODEL NUMBER:	5-12M-10	
I-BEAM:	S4" X 7.7#/' X 10'	
I-BEAM LENGTH (OVERALL SPAN):	120 Inches	
MAXIMUM CANTILEVER DISTANCE (A):	30 Inches	
GANTRY RATED CAPACITY:	500 Lbs.	
MAXIMUM CANTILEVERED LOAD (B):	300 Lbs.	
GANTRY WEIGHT:	359 Lbs.	
I-BEAM WEIGHT:	80 Lbs.	

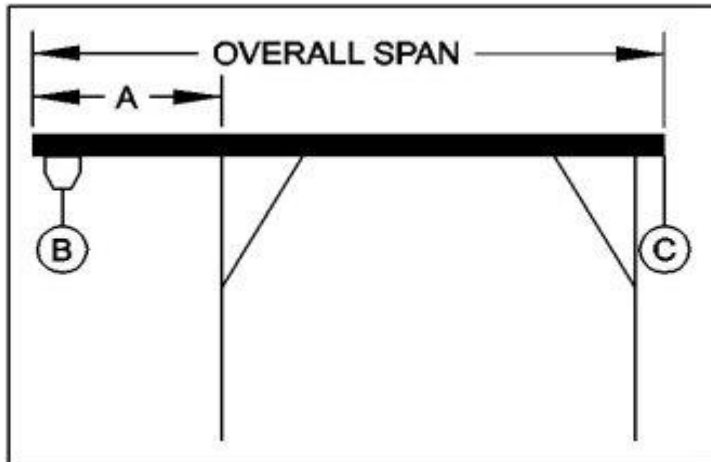

PROPER CANTILEVER PROCEDURES
Required counterweight should not be supported by gantry caster frame.

Load and trolley should be able to freely traverse the I-beam through the main legs and brace legs of the gantry.

REQUIRED COUNTERWEIGHT AT [C]

A	B	B	B
IN	100	200	300
FEET	LBS.	LBS.	LBS.
1	0	0	0
2	0	0	0
2.5	0	0	33