

MODEL NUMBER S6T10-15SAC

ITEM NO.	PART DESCRIPTION	PART NUMBER	QUAN.
1	MAIN LEG BRACKET	1552-0000	4
2	SUPPORT PIN 11/16 DIA. X 4 9/16 LG.	5017-0004	4
3	SPACER BAR 20 5/16 LG.	1744-0003	2
4	COTTER PIN 1/4 X 1 1/4 LG.	60-0070	8
5	NEX. NUT 3/8-24NC	54-0100	4
6	SOC. SET SCREW 3/8-24NF X 1 3/4 LG.	63-0110	4
7	SOC. SET SCREW 3/8-24NF X 1 LG.	63-0100	4
8	LEG BRACE BRACKET	1762-0000	4
9	SUPPORT PIN 11/16 DIA. X 4 1/8 LG.	2853-0000	4
10	MAIN LEG SWIVEL PIN	1559-0000	4
11	LEG BRACE SWIVEL PIN	1563-0000	4
12	HEX. HD. BOLT 3/4-10NC X 2 1/2 LG.	51-0480	4
13	TROLLEY STOP ANGLE	5132-0000	4
14	KEY RING 2 1/4 OD.	82-0030	10
15	CAUTION TAG No. 399	1969-RING	12
16	LOCK WASHER INT. TOOTH 3/4	58-0040	4
17	HEX. NUT 3/4-10NC	54-0040	4
18	I BEAM STL. 10" X 15' LG.	762-0150	1
19	LEG BRACE ASSEMBLY	1543-0060	4
20	MAIN LEG ASSEMBLY	1665-0061	4
21	UPPER MAIN LEG	1666-0060	4
22	ROLL PIN 5/32 X 3/4 LG.	61-0300	4
23	LOAD PIN	3016-0000	4
24	EXTENSION SPRING	1017-0000	8
25	LOWER MAIN LEG	1662-0060	4
26	CASTER FRAME ASSEMBLY	699-0010	2
27	LOWER MAIN LEG PIN ASSEMBLY	1999-0000	4
28	HEX. HD. BOLT 1/2-13NC X 5 1/2 LG.	51-0470	4
29	SAFETY CABLE ASS'Y 78" LG.	1968-0010	2
30	OUTER CASTER FRAME TUBE	700-0010	2
31	CASTER FRAME ADJUSTMENT PIN	1392-0000	2
32	INNER CASTER FRAME TUBE	701-0010	2
33	CASTER CASTING FOR INNER TUBE	2630-0000	2
34	CASTER CASTING FOR OUTER TUBE	2629-0000	2
35	LOCK WASHER INT. TOOTH 1/2	58-0020	4
36	HEX. NUT 1/2-13NC	54-0050	4
37	HEX. HD. BOLT 1/2-13NC X 1-1/2" LG.	51-0290	16
38	LOCK WASHER INT. TOOTH 1/2	58-0020	16
39	HEX. NUT 1/2-13NC	54-0050	16
40	CASTER WHEEL 8" DIA.	47-81NB	4
41	SAFETY STOP ASSEMBLY	3112-0001	4



# Wallace Cranes Parts Location

Round Tube Tri-Adjustable

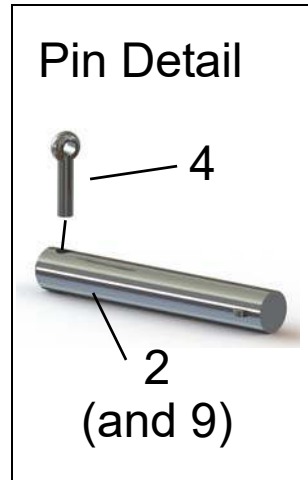

I-Beam  
Assembly  
Parts Location

Wallace Cranes  
71 N Bacton Hill Rd.  
Malvern, PA 19355



[www.wallacecranes.com](http://www.wallacecranes.com)  
800-553-5438  
©2017 All rights reserved



Caster Frame  
Assembly  
Parts Location

Wallace Cranes  
71 N Bacton Hill Rd.  
Malvern, PA 19355



www.wallacecranes.com  
800-553-5438  
©2017 All rights reserved